

DECKENLEUCHTEN

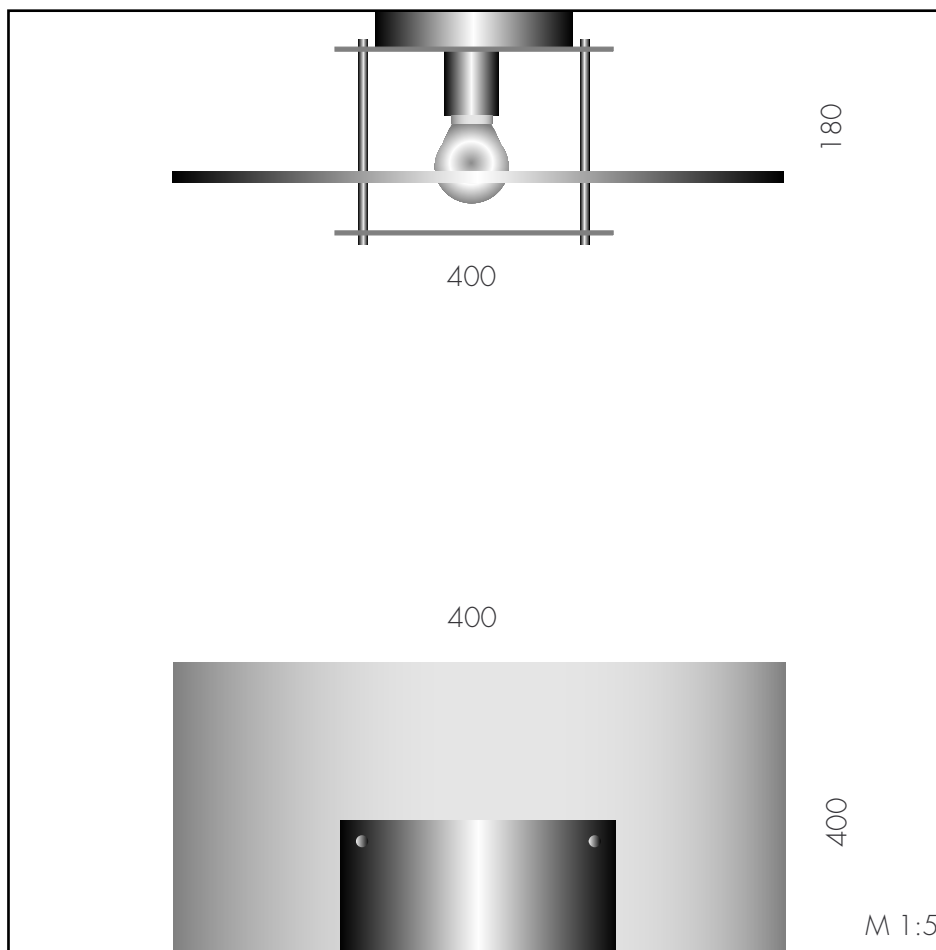

SQUARES I DA



SQUARES I

Leuchentyp	Deckenleuchte	Type of Lamp	Ceiling lamp
Material	Edelstahl/Glas	Material	Stainless steel/Glass
Oberfläche	gebürstet/sandgestrahlt	Surface	Brushed/Sandblasted
Leuchtmittel	Agl. 100 W ringverspiegelt	Lamp	Tungsten lamp 100 W
Vorschaltgerät	optional	Ballast	Optional
Optionen	TC - TEL 18/26 W	Options	TC - TEL 18/26 W
Einsatzbereich	direktes+indirektes Raumlicht	Use	Direct+indirect lighting



SQUARES I DE

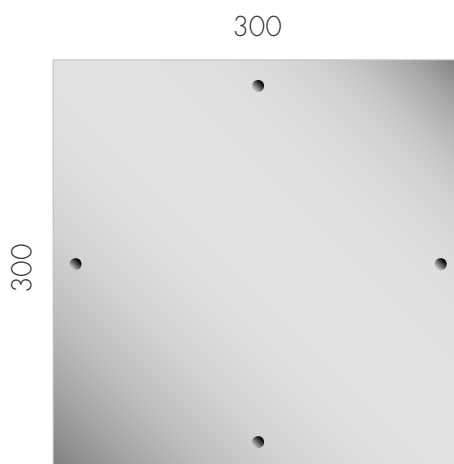
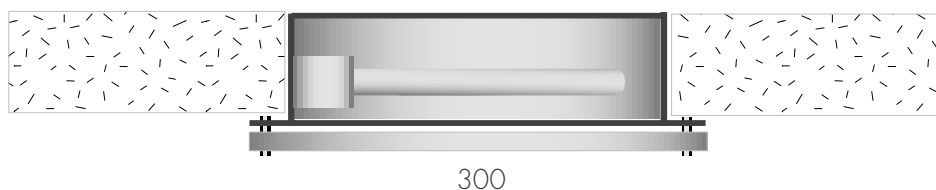

M 1:5

SQUARES I DE

Leuchentyp	Deckenleuchte	Type of Lamp	Ceiling lamp
Material	Edelstahl/Glas	Material	Stainless steel/Glass
Oberfläche	gebürstet/sandgestrahlt	Surface	Brushed/Sandblasted
Leuchtmittel	TC- L 1(2) x 18 W TC-F 36 W	Lamp	TC- L 1(2) x 18 W TC-F 36 W
Vorschaltgerät	EVG	Ballast	Electronic
Zubehör	Blendraster (Deckenversion) Notlichtausstattung	Attachements	Blinds(ceiling version) Emergency lighting
Optionen	VSG/Drahtglas	Options	Security Glass
Einsatzbereich	direktes Raumlicht	Use	Direct lighting



PAN DA 40



80 mm

d=400 mm



50 mm

d=260 mm

400 mm (FC 40/55 W)

260 mm (FC 22 W)

M 1:5

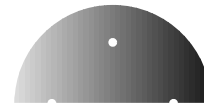
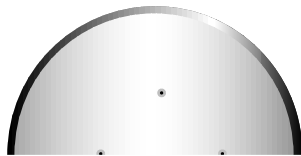

PAN DA

Leuchentyp Wand/Deckenleuchte
 Material Aluminium/Glas/Acryl
 Oberfläche eloxiert/sandgestrahlt
 Leuchtmittel TR 22/32/40 W (Ring)
 FC 22/40/55 W(Ring)
 Vorschaltgerät EVG
 Zubehör Notlichtausstattung
 Optionen Stahl lackiert RAL 9010
 Drahtglas oder VSG
 Einsatzbereich direktes Raumlicht

Type of Lamp Wall /Ceiling lamp
 Material Aluminium/Glass/Acrylic
 Surface Anodized/sandblasted
 Lamp TR 22/32/40 W (Ring)
 FC 22/40/55W(Ring)
 Ballast Electronic
 Attachements Emergency lighting
 Options Body thermolacquered
 Use Direct lighting



TAVOLA DA



80 mm

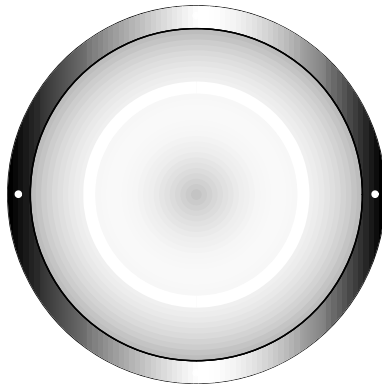

300 mm (FC 22 W)
400 mm (FC 40/55 W)

M 1:5

TAVOLA DA

Leuchentyp	Wand/Deckenleuchte	Type of Lamp	Wall /Ceiling lamp
Material	Aluminium/Glas/Acryl	Material	Aluminium/Glass/Acrylic
Oberfläche	eloxiert/sandgestrahlt	Surface	Anodized/sandblasted
Leuchtmittel	TR 22/32/40 W (Ring) FC 22/40/55 W(Ring)	Lamp	TR 22/32/40 W (Ring) FC 22/40/55W(Ring)
Vorschaltgerät	EVG	Ballast	Electronic
Zubehör	Notlichtausstattung	Attachements	Emergency lighting
Optionen	Stahl lackiert RAL 9010 Drahtglas oder VSG	Options	Body thermolacquered
Einsatzbereich	direktes Raumlicht	Use	Direct lighting

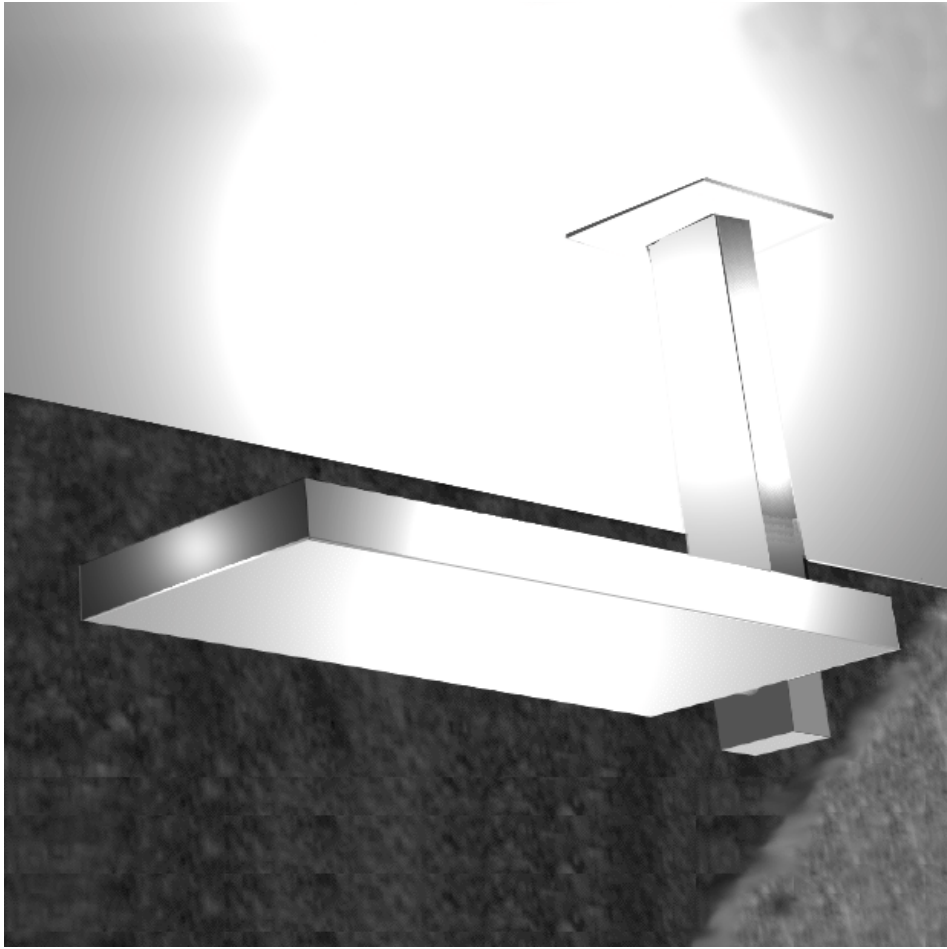

UTURN DA 55

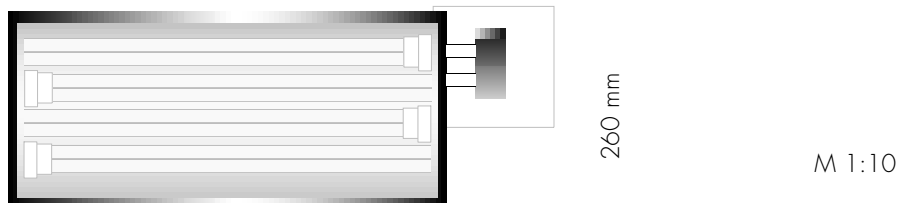
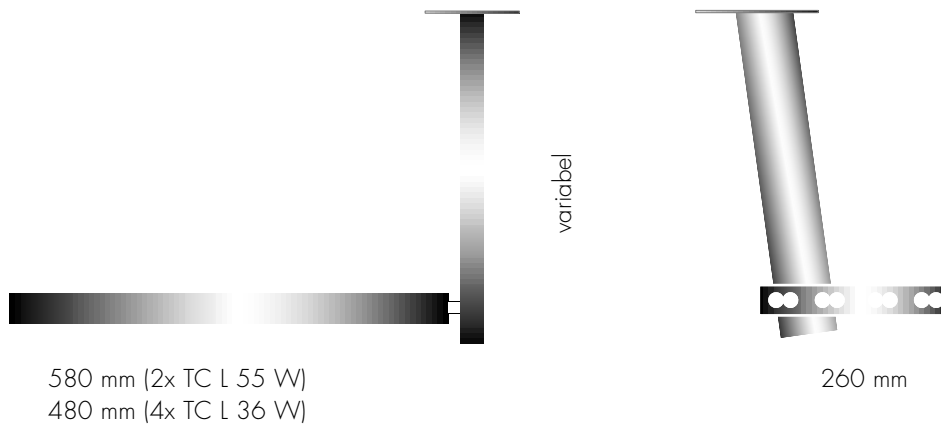

UTURN DA

Leuchentyp	Deckenleuchte	Type of Lamp	Ceiling -Lamp
Material	Aluminium	Material	Aluminium
Oberfläche	eloxiert	Surface	Anodized
Leuchtmittel	2(4)x TC- L 36/55 W	Lamp	2(4)x TC- L 36/55 W
Vorschaltgerät	EVG	Ballast	Electronic
Zubehör	Notlichtausstattung	Attachements	Emergency lighting
Optionen	variable abhängung	Options	Custom-made suspension
Einsatzbereich	direktes+indirektes Raumlicht	Use	Direct+indirect lighting